

RMD-SERIES

5-INPUT MIXER-AMPLIFIER with Bluetooth, DAB+/FM, USB/SD player

RM60D: 953.223UK

RM120D: 953.224UK

RM240D: 953.225UK

RM360D: 953.226UK

User Manual

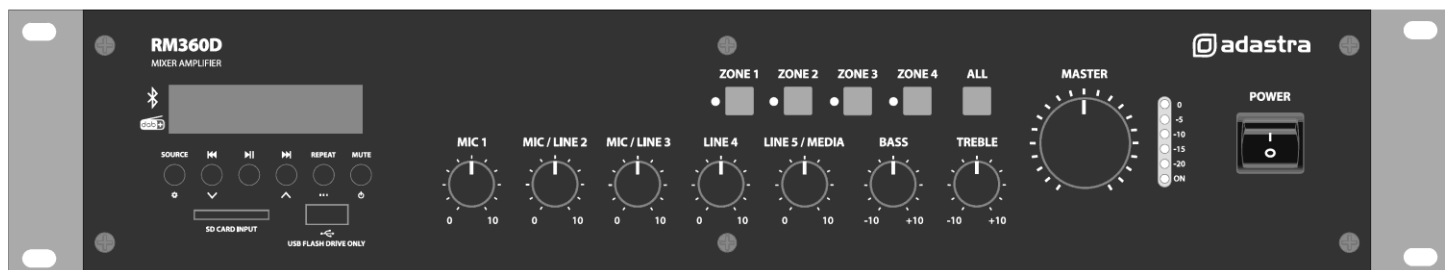
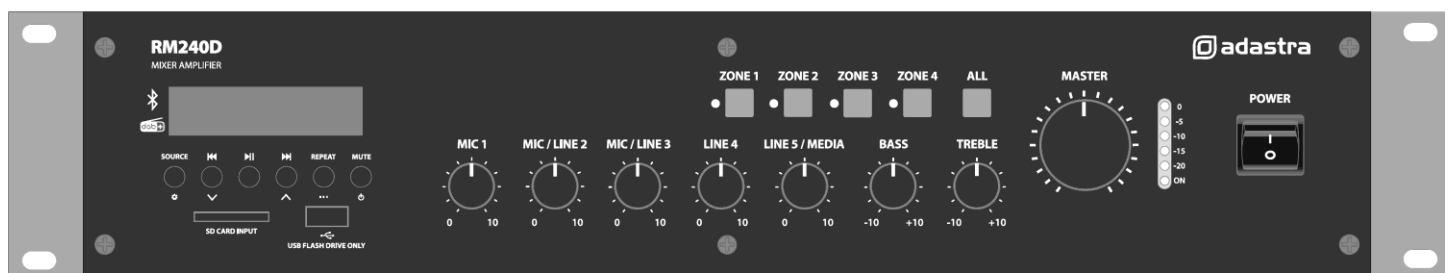
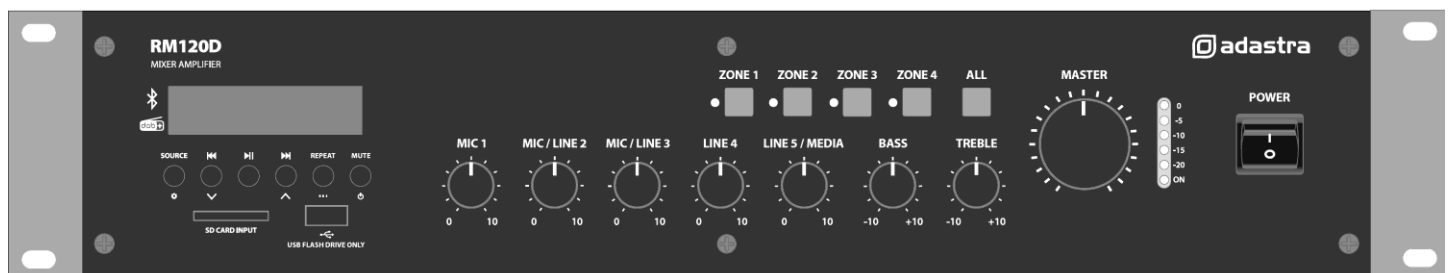
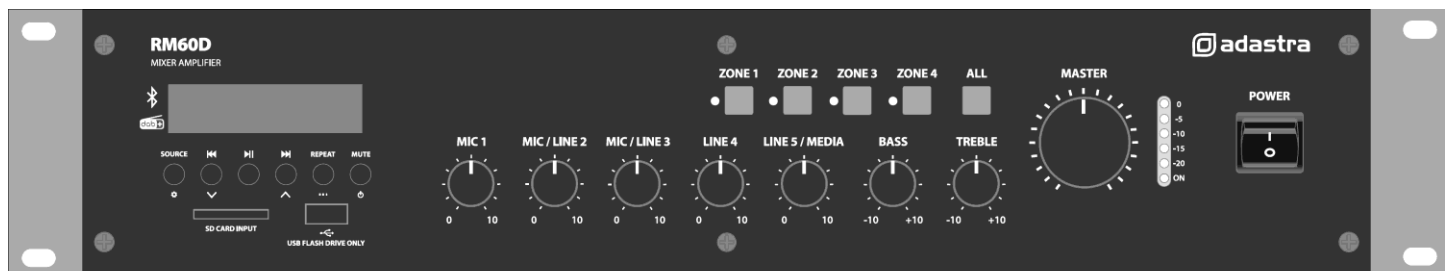

Version 1.0



Caution: Please read this manual carefully before operating
Damage caused by misuse is not covered by the warranty

Introduction

Thank you for choosing the Adastra RMD-series rackmount 100V amplifier as part of your public address system. This amplifier is designed to offer high quality, dependable service for mobile and installed systems. Please read this manual fully and follow the instructions to achieve the best results with your new purchase and to avoid damage through misuse.

SAFETY SYMBOL AND MESSAGE CONVENTIONS



CAUTION
RISK OF ELECTRIC SHOCK
DO NOT OPEN

AVIS
RISQUE DE CHOC ELECTRIQUE NE PAS
OUVRIR



This symbol indicates that dangerous voltage constituting a risk of electric shock is present within this unit



This symbol indicates that there are important operating and maintenance instructions in the literature accompanying this unit.



SAFETY NOTICE

1. Prior to use, read through this manual
2. Keep the manual in good condition
3. Pay attention to safety warnings
4. Observe all operating requirements
5. Do not use the device near water or wet areas
6. For cleaning, only use a lint-free, dry cloth
7. Install according to the specifications
8. Place away from heat sources or heating appliances
9. Use mains lead provided and avoid damage to cable or connectors
10. Unplug power from mains during stormy weather or if unused for long periods
11. In case of malfunction, water ingress or other damage, consult qualified service personnel
12. Do not place in damp areas or near liquids or moisture. Do not spill liquids on the housing
13. Please pay attention to warning symbols during transit and placement
14. Terminals marked with the $\frac{1}{2}$ symbol are HAZARDOUS LIVE and should only be connected by qualified personnel
15. Ensure that the apparatus is connected to a mains socket with a protective EARTH connection
16. Ensure correct operation of the mains switch

Warning

To prevent the risk of fire or electric shock, do not expose any components to rain or moisture.

If liquids are spilled on the casing, stop using immediately, allow unit to dry out and have checked by qualified personnel before further use. Avoid impact, extreme pressure or heavy vibration to the case

No user serviceable parts inside – Do not open the case – refer all servicing to qualified service personnel.

Safety

- Check for correct mains voltage and condition of IEC lead before connecting to power outlet
- Use double insulated speaker wire with adequate current rating for 100V speaker connections
- Only use one type of output – i.e. 4-16 Ω or 100V – do not mix or combine these outputs on a single zone or output
- Do not connect 4-16 Ω speakers to the 100V terminal or 100V speakers to the 4-16 Ω terminal
- Do not allow any foreign objects to enter the case or through the ventilation grilles

Placement

- Keep out of direct sunlight and away from heat sources
- Keep away from damp or dusty environments
- For rack-mounting, use the rack ears provided and ensure adequate support for the weight of the amplifier
- Ensure adequate air-flow and do not cover cooling vents at the front and rear of the amplifier
- Ensure adequate access to controls and connections

Cleaning

- Use a soft cloth with a neutral detergent to clean the casing as required
- Use a vacuum cleaner to clear ventilation grilles of any dust or debris build-ups
- Do not use strong solvents for cleaning the unit

Front panel

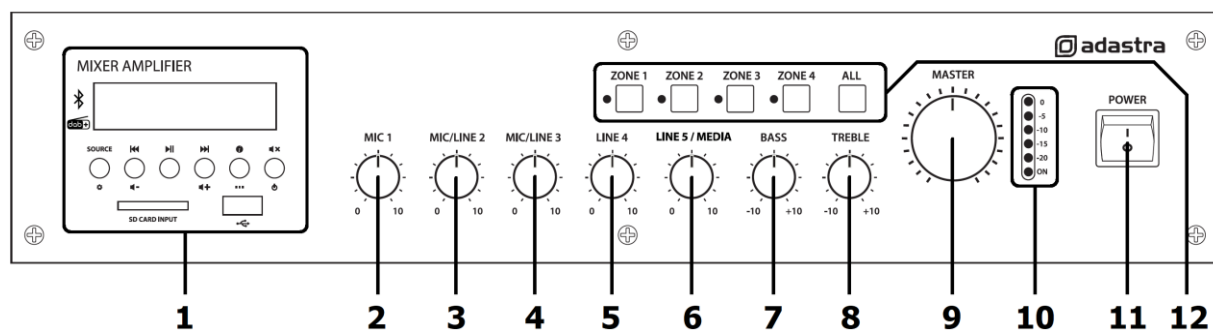

- | | |
|---------------------------------------|-----------------------------------|
| 1. USB/SD/DAB+/FM/BT media player | 7. BASS EQ control |
| 2. MIC 1 volume control | 8. TREBLE EQ control |
| 3. MIC/LINE 2 volume control | 9. MASTER volume control |
| 4. MIC/LINE 3 volume control | 10. VU level meter |
| 5. LINE 4 volume control | 11. POWER on/off switch |
| 6. LINE 5/MEDIA player volume control | 12. Speaker zone selector buttons |

Rear panel

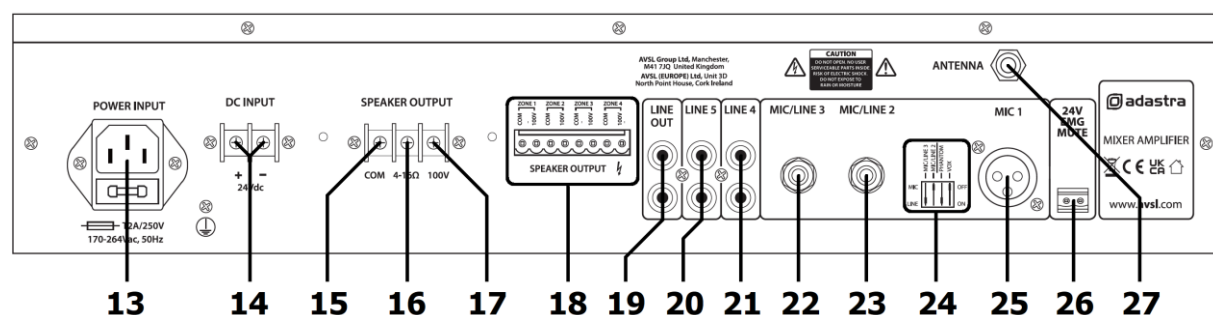

- | | |
|--|---|
| 13. IEC mains inlet & fuse holder | 21. LINE 4 input (RCA) |
| 14. DC power terminals | 22. MIC/LINE 3 input (6.3mm jack) |
| 15. COM speaker terminal | 23. MIC/LINE 2 input (6.3mm jack) |
| 16. 4-16Ω speaker terminal | 24. DIP switches (see DIP switches section below) |
| 17. 100V speaker terminal (unswitched) | 25. MIC 1 input (balanced XLR) |
| 18. 100V speaker terminals (zone switched) | 26. 24V Mute contacts |
| 19. LINE OUT connectors (RCA) | 27. Antenna connection for DAB+/FM tuner |
| 20. LINE 5 input (RCA) | |

DIP switches (24)

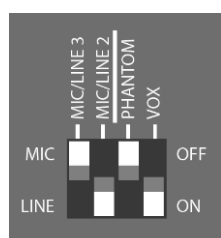

MIC 1 input (25) has an option for +20V phantom power for condenser microphones and paging microphones with chimes.

MIC 1 also has the option of VOX control, which attenuates the line input channels 4 and 5 by -40dB when MIC 1 signal is detected and returns them to normal when MIC 1 signal is silent.

MIC/LINE 2 (23) and MIC/LINE 3 (22) inputs can be set to MIC (up position) or LINE (down position) sensitivity to suit the type of input being used. Be sure to make these DIP switch settings when the amplifier is switched off. Making any changes when the amplifier is powered up may cause loud noises which can damage the speakers.

Connection and setup

Connect the rear IEC inlet (13) to the mains using the supplied mains lead (or an equivalent approved type).

Alternatively, the amplifier can be powered by a 24V battery, such as a lorry or boat battery, by connecting the "+" and "-" of the battery to the DC INPUT (14) on the rear panel. Ensure that DC cables are capable of handling the required current (20A recommended)

The RMD series amplifiers have a total of 5 input channels. MIC 1 input (25) is fed to a dedicated microphone channel. Connect the main announcement microphone to this channel using a balanced XLR lead.

Connect microphones or mono line inputs to MIC/LINE 2 and MIC/LINE 3 inputs (23, 22) using good quality 6.3mm jack leads. Make sure the correct sensitivity is selected for the type of input source.

Connect any other line level audio inputs to the LINE 4 (21) and LINE 5 (20) connectors on the rear panel using good quality RCA leads. Since RMD series amplifiers have a mono output, all stereo signals are summed together.

Further mixer-amplifiers or slave amplifiers can be connected from the rear LINE OUT sockets (19), again using a good quality RCA lead. This output carries the full mix of all channels 1-5 as fed to the speakers.

Speaker outputs

The RMD series amplifiers can be used either as 100V line amplifiers or standard low impedance power amplifiers. These 2 configurations cannot be used together, so it is important to decide which method will be used at the start.

100V line systems

For 100V line systems, connect the amplifier to the first speaker in the system using double-insulated speaker wire which has adequate current rating to handle the total output of the amplifier.

Connect the "100V" (17) output terminal to the positive (+) connection of the speaker and "COM" output (15) to the negative (-) connection of the speaker. Connect further speakers in parallel to the first speaker with all positive terminals and connected together and all negative terminals connected together as shown below.

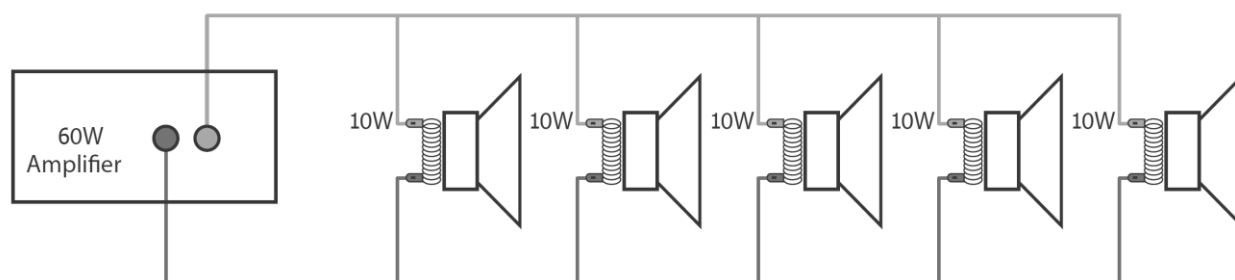

A 100V line speaker system can comprise of many speakers connected together in parallel. The determining factor for how many speakers can be used on a single amplifier is the power rating. For most purposes, it is advised to connect as many speakers as needed with a combined wattage of no more than 90% of the amplifier's output power rating.

The terminals of a 100V speaker are connected to a transformer and in some cases, this transformer may be "tapped" for different power ratings. These tapings can be used to adjust the wattage (and output volume) of each speaker in the system to help achieve the ideal total power of the system for the amplifier.

Speaker switching zones

Any 100V speakers connected to the removable screw terminals labelled ZONE 1 / ZONE 2 / ZONE 3 / ZONE 4 will be governed by 4 front panel speaker switches (18).

(e.g. a speaker connected to ZONE 1 + COM will be enabled if Zone 1 button is depressed on the front panel) There is also a switch labelled "ALL" on the front panel which enables output to all Zones 1 to 4.

If 100V speakers are needed for emergency evacuation or do not need to be switched on or off via the front panel, it is better to wire the "+" wire to the fixed unswitched 100V terminal (17) and the "-" wire to COM (15)

Low impedance systems

Alternatively, RM series amplifiers can be used to drive low impedance speakers by connecting the 4-16 Ω terminal (16) to the "+" speaker connection and COM terminal (15) to the "-" speaker connection.

Do not use 4-16 Ω and 100V at the same time.

Emergency mute function

RM series mixer-amplifiers are equipped with a Euroblock connector for a 24V mute function (26).

These contacts can be wired to an emergency panel (such as a fire alarm) which has a 24V trigger output. (The 24V contacts can be connected with either polarity +/- or -/+ to operate)

When the alarm is activated, the RM mixer-amplifier will mute all channels except for MIC1, which remains active for emergency announcements.

Operation

When all connections to the amplifier are made, turn all rotary controls down and switch on the power (11) and a power "ON" LED will illuminate. Press in the "ALL" zones button for testing so that none are muted (12)

Turn BASS and TREBLE controls (7, 8) to the 12 o'clock position (pointing straight up) and turn the MASTER rotary control (9) up part way for testing.

Ensure a signal is being fed to one of the line inputs and gradually increase the volume control for that channel (2, 3, 4, 5 or 6) until the output is heard through the speakers.

Turn up the MASTER to the maximum required volume level and reduce the channel volume control if necessary.

Repeat this process for any other line inputs connected to channels 2, 3, 4, 5 or 6.

Note: If a line input is not connected to an RMD series mixer-amplifier, the initial test can be made using the built-in media player. See the "Media player" section for instructions.

Note: Both the media player output and LINE 5 input are governed by the LINE 5 / MEDIA volume control (6)

The output of the amplifier is represented on the VU meter LEDs (10) and care should be taken that the red "0" LED is only lit momentarily during use. Anything longer than a short flash of this LED may be indicating distortion or clipping of the output signal and the MASTER volume control or channel volume control should be turned down.

If a microphone is connected to MIC 1 input, make sure it is switched on and if it requires phantom power, make sure this feature is enabled on the DIP switch. Gradually increase the MIC 1 control (2) whilst speaking into the microphone until the required volume level is reached.

The microphone should not be able to "hear" the speakers, which can cause feedback (squealing or howling)

Repeat this process for microphones or line inputs connected via the MIC/LINE 2 and 3 inputs.

If the VOX feature is enabled on the DIP switches, audio playback through channels 4 and 5 will be reduced in volume automatically when speaking into MIC 1.

In addition to channel and MASTER volume controls, there are BASS and TREBLE EQ controls (7, 8) to adjust the tone of the overall output. At the 12 o'clock position, these controls apply no effect to the signal (no boost or cut).

Moving the BASS control clockwise boosts the low frequencies in the audio, whilst moving it anticlockwise will cut these low frequencies. Likewise, moving the TREBLE control clockwise boosts the high frequencies in the audio, whilst moving it anticlockwise will cut these high frequencies.

Adjust these EQ controls to suit the type of audio signal or compensate for the room acoustics.

Media player

The RM120D mixer-amp is fitted with a built-in media player (1). The media player has a Bluetooth receiver, USB/SD audio player and a DAB+ or FM radio tuner. Pressing the SOURCE select button will step through Bluetooth, SD, USB, DAB and FM tuner modes. Pressing the MUTE button for any source will mute the output. Holding the MUTE button powers down the media player and pressing it again powers it up again.

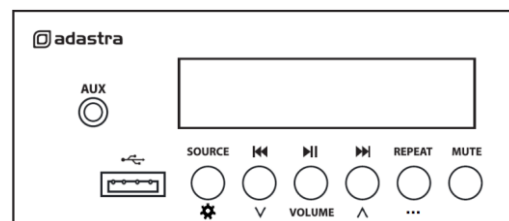

Settings menu

The media player has a menu for global settings, which can be accessed by holding down the SOURCE button. Press ◀ and ▶ to step through menu pages and ▶ to select an option. Press REPEAT / ... to go back.

Setting	Press ▶	Press ▶ to step through settings and enter. Use ◀ and ▶ to adjust values
<Time >	<Set Time/Date >	DD-MM-YYYY... HH:MM
	<Set 12/24 hour >	<Set 24 hour> / <Set 12 hour>
	<Set date format>	<DD-MM-YYYY> / <MM-DD-YYYY>
	<Auto update >	<Update from Any> / <No Update> / <Update from FM> / <Update from DAB >
<Backlight >	<Timeout >	< On / 10 Sec / 20 Sec / 30 Sec / 45 Sec / 60 Sec / 90 Sec / 120 Sec / 180 Sec >
	<On level >	<Low> / <Medium> / <High> (brightness)
<Language >	<English> / <Deutsch> / <Italiano> / <Français> / <Español> / <Português>	
<Factory Reset >	<No> / <Yes> ("Yes" will reset and starts a re-scan for DAB, Bluetooth will need to be re-paired)	
<SW version >	Displays the current software version	

Bluetooth

Search available Bluetooth devices on your smart phone or other sending device for a device with Bluetooth ID "adastra-****" (where **** is a unique ID number for each unit). Select to pair and connect with this ID.

When paired and connected, set the volume low on the smart phone or other sending device and play a track to check the sound through the speakers, increasing the volume on the smart phone to the required level.

Playback controls on the media player can remotely operate the smart phone from the amplifier front panel. Pressing ▶ will pause or play the current track, whilst holding ▶ will disconnect the current paired device. Pressing ◀ or ▶ will select the previous or next track. Holding ◀ or ▶ will decrease or increase the output volume. Pressing the REPEAT / ... button will switch the display to show the current time or date on the lower text line.

If there is no Bluetooth playback for 15 minutes, the display will revert to show the current time and date.

SD and USB audio player

The media player can play mp3 or wma files stored on a USB stick or SD card (formatted FAT32 or exFAT) Select SD or USB using the SOURCE button and insert the SD or USB storage device containing the tracks. The display will show the play status, USB or SD and repeat status on the upper test line.

Pressing ► || will pause or play the current track, whilst ◀◀ or ▶▶ will select the previous or next track. Holding the ◀◀ or ▶▶ button will decrease or increase the output volume of the media player.

The repeat mode can be set by holding the REPEAT/... button, pressing ► ||, and selecting using ◀◀ or ▶▶. NR = Normal (no repeat), RA = Repeat All, R1 = Repeat One (current track), Rd = Random.

Pressing the REPEAT/... button selects the lower text line information, cycling through ID3 info, time & date. If there is no SD or USB playback for 15 minutes, the display will revert to show the current time and date.

DAB tuner

The media player has a digital radio receiver which can decode the DAB/DAB+ signal for high quality radio reception. To receive this signal, connect the DAB/FM Aerial 'F' connector on the rear panel (27) to an external or indoor active aerial that can receive the DAB/DAB+ frequency band (174-240MHz).

Press and hold the ► || button to initiate auto-tuning for the DAB radio tuner. The display will show "Scanning..." with a progress bar and the number of stations detected and stored.

The display will show the current station in the upper row of text and additional information on the lower row. Select the station to be played using the ◀◀ and ▶▶ buttons.

Pressing the REPEAT/... button will cycle the display to show additional tuning, audio information, current time or date. Holding this button opens a sub-menu for the FM tuner.

Setting		Press ► then use ◀◀ and ▶▶ to step through settings and ► again to select.
<Full scan	>	Press ► to scan and store all available stations
<Preset Recall	>	Select a stored station (use ◀◀ and ▶▶ to select 1-30)
<Preset Store	>	Select a memory slot (use ◀◀ and ▶▶ to select 1-30) and ► to store current station in the slot
<Manual tune	>	Use ◀◀ and ▶▶ to step through DAB frequency band
<Prune	>	<No> / <Yes> (removes any redundant stations from memory)
<DRC	>	<off> / <low> / <high> setting for dynamic range compression (loud vs quiet sound balance)

FM Tuner

The FM tuner function operates in the same way as a standard FM radio and benefits from the connection of an FM antenna to the rear panel 'F' type connector.

If no channels are tuned in, press the Play/Pause ► || button to begin auto tuning, which scans available stations and stores them as channels within the FM tuner. Pressing Play/Pause again will abort auto-tuning.

To delete any selected station, press and hold the REPEAT button. Repeat the auto tuning process to re-populate any missing presets.

To step through pre-set stations, press the Previous ◀◀ or Next ▶▶ buttons. Turn up the MEDIA volume control to hear the output from the speakers and increase to the required level.

Holding the Previous ◀◀ or Next ▶▶ buttons will adjust the output volume of the player.

Pressing the REPEAT/... button will cycle the display to show additional tuning, audio information, current time or date. Holding this button opens a sub-menu for the FM tuner.

Setting		Press ►
<Preset Recall	>	Select a stored station (use ◀◀ and ▶▶ to select 1-30)
<Preset Store	>	Select a memory slot (use ◀◀ and ▶▶ to select 1-30) and ► to store current station in the slot
<Scan Setting	>	<All stations> / <Strong station> (only stores stations with a strong signal)
<Audio Setting	>	<Stereo allowed> / <Forced mono>

Specifications

Model	RM60D	RM120D	RM240D	RM360D
Power supply	170-264Vac, 50Hz (IEC) or 24Vdc (screw terminals)			
Signal inputs / output	Mic XLR, 2 x mic/line jack, 2 x RCA line, RCA line output			
Input sensitivity: mic 1	-53dBV			
Input impedance: mic 1	5k Ohms			
Input sensitivity: line	-15dBV (-18.5dBV line 5)			
Input impedance: ch.2-5	1k Ohms			
Speaker outputs	4 switched + 1 non-switched 100V / 4-16 Ohms / COM			
Controls	Mic1, mic/line2+3, line4+5, bass, treble, master volume			
Equalizer: bass	100Hz \pm 10dB			
Equalizer: treble	10kHz \pm 10dB			
Rear panel switches	Phantom, Vox, Mic/Line (2 + 3)			
Phantom power	+20V (mic 1 XLR, switchable)			
Audio source	DAB+/FM tuner, USB/SD player, Bluetooth receiver			
Emergency control	24V contacts - mute all except Mic.1 when triggered			
THD	<1.0%			
Output power: rms	60W	120W	240W	360W
Fuse	T2A	T3.15A	T5A	T5A
Dimensions	433 x 320 x 88mm	433 x 320 x 88mm	433 x 320 x 88mm	433 x 410 x 88mm
Weight	4.98kg	6.36kg	7.37kg	9.14kg

Troubleshooting

Poor or no DAB/DAB+/FM reception	Ensure DAB/FM aerial is connected within an area of good radio reception
Bluetooth cannot connect	Ensure that Bluetooth is enabled on sending device
	Ensure that the sending device is within Bluetooth range (5-10m)
	Check that "adastra ****" is the connected device
	If there are more than one "adastra ****" devices, check each in turn
No audio from Bluetooth device	Ensure that volume controls are not turned down on sending device
	Check volume and Play/Pause buttons in case Bluetooth is muted
No playback from USB or SD device	Ensure media is formatted to FAT32 and files are standard mp3/wma type
Output too loud or distorted	Reduce MIC, LINE IN, USB/SD and/or MASTER level
	Ensure Hi-Z line level input(s) not connected via MIC input
Output too quiet or inaudible	Increase MIC, LINE IN, USB/SD and/or MASTER level
	Check for quiet recording of media files on USB
	Check VOX override is not unintentionally suppressing audio playback
No microphone output	Check phantom power is enabled if using a condenser microphone
Feedback from microphone	Face microphone away from speakers and monitors and reduce level
Amplifier overheating	Ensure cooling vents are clear from debris and dust
	Check that 4, 8 or 16 Ω speakers are not connected to 100V terminals
	Ensure total 100V speaker wattage is lower than amplifier rating
	Ensure that 100V and 4, 8 or 16 Ω speakers are not both connected
	Ensure that total load connected to 4 - 16 Ω output is not less than 4 Ω



Disposal: The "Crossed Wheelie Bin" symbol on the product means that the product is classed as Electrical or Electronic equipment and should not be disposed with other household or commercial waste at the end of its useful life. The goods must be disposed of according to your local council guidelines.

Hereby, AVSL Group Ltd. declares that the radio equipment type 953.223UK, 953.224UK, 953.225UK and 953.226UK are in compliance with [Directive 2014/53/EU](#)

The full text of the EU declaration of conformity for 953.223UK is available at the following internet address:
<http://www.avsl.com/assets/exportdoc/9/5/953223UK%20CE.pdf>

The full text of the EU declaration of conformity for 953.224UK is available at the following internet address:
<http://www.avsl.com/assets/exportdoc/9/5/953224UK%20CE.pdf>

The full text of the EU declaration of conformity for 953.225UK is available at the following internet address:
<http://www.avsl.com/assets/exportdoc/9/5/953225UK%20CE.pdf>

The full text of the EU declaration of conformity for 953.226UK is available at the following internet address:
<http://www.avsl.com/assets/exportdoc/9/5/953226UK%20CE.pdf>

*Errors and omissions excepted. Copyright© 2023,
 AVSL Group Ltd. Unit 2-4 Bridgewater Park, Taylor Rd. Manchester. M41 7JQ
 AVSL (EUROPE) Ltd, Unit 3D North Point House, North Point Business Park, New Mallow Road, Cork, Ireland.*